

# Installation guide – first steps

AS-Interface is designed as a potential-free and ground-symmetrical system. It offers high interference immunity even without additional measures, such as shielding in industrial environments.



## AS-Interface key features



Transmission of data and power on the same cable



Protection class IP20 to IP67, depending on housing model



Maximum cable length of 200 m with bus termination



Standard and safety signals on the same AS-Interface cable



Freely choose your topology



For better understanding, please watch out for the following symbols:

- This installation offers the highest interference resistance and helps to avoid errors.
- This installation may be prone to faults, interferences and errors.
- This installation will lead to faults, interferences and errors in the ASi communication.



## ASi-5 Topologie

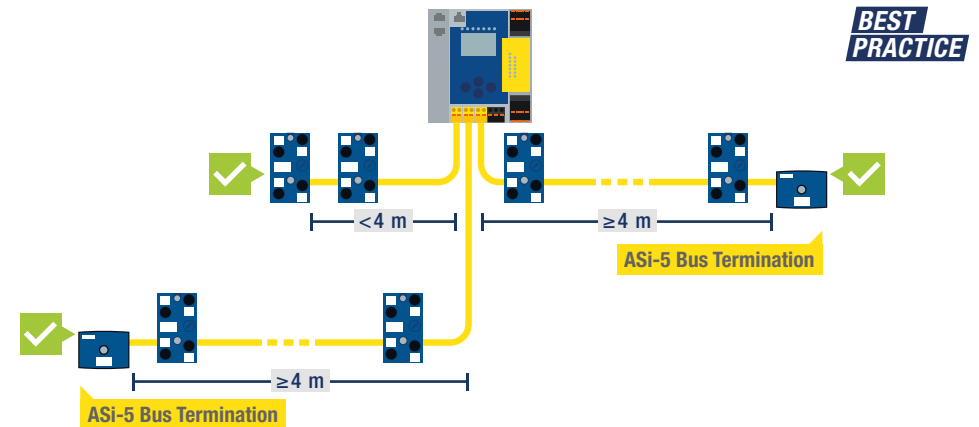
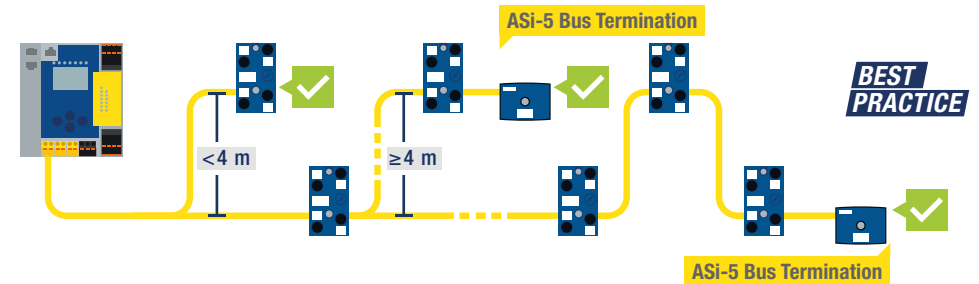
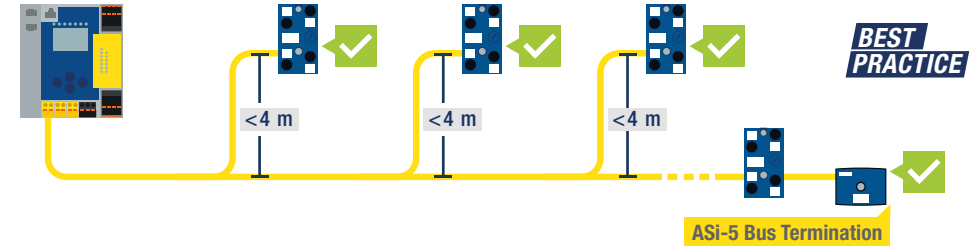

- ▶ An ASi-5 bus termination at the end is recommended.
- ▶ Branches/stub lines >4 m should be terminated at the end with an ASi-5 bus termination.
- ▶ Max. 5 ASi-5 bus terminations per ASi circuit possible.



### Installation in the Control Cabinet

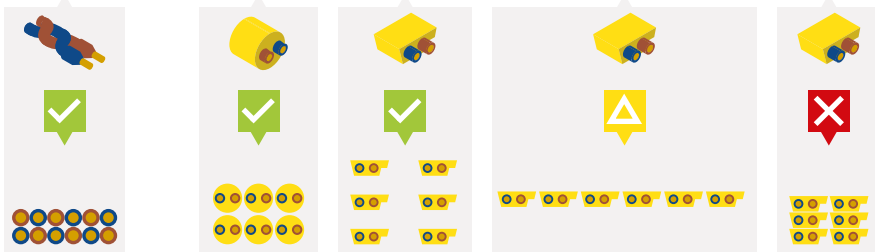
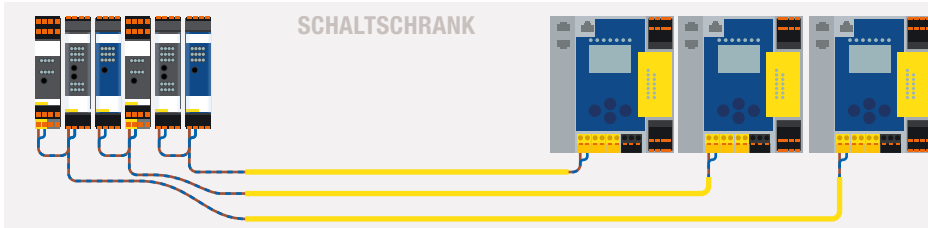

### Installation in the field / EMV

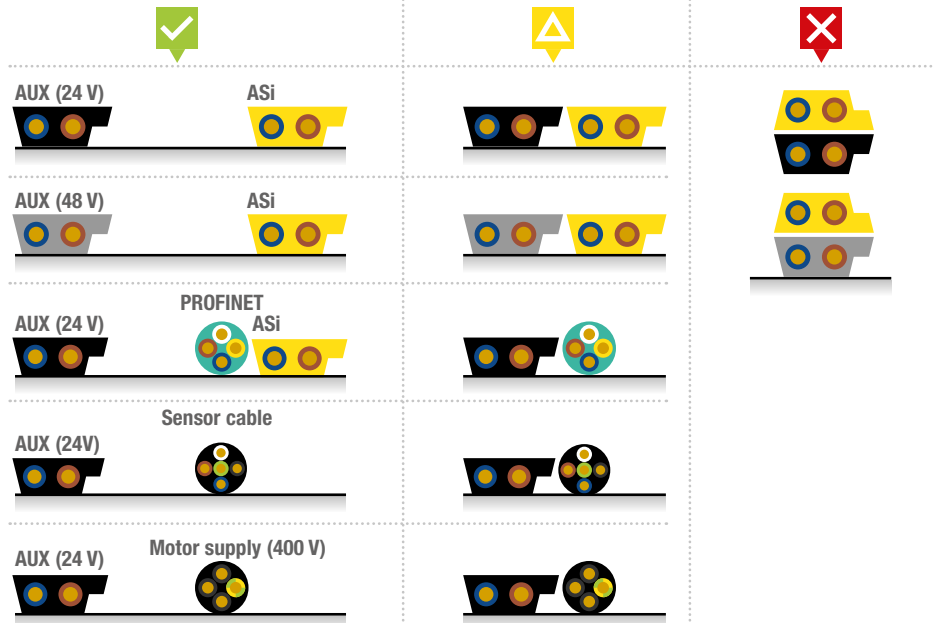

### Installation in the field / minimizing ASI-5 crosstalk

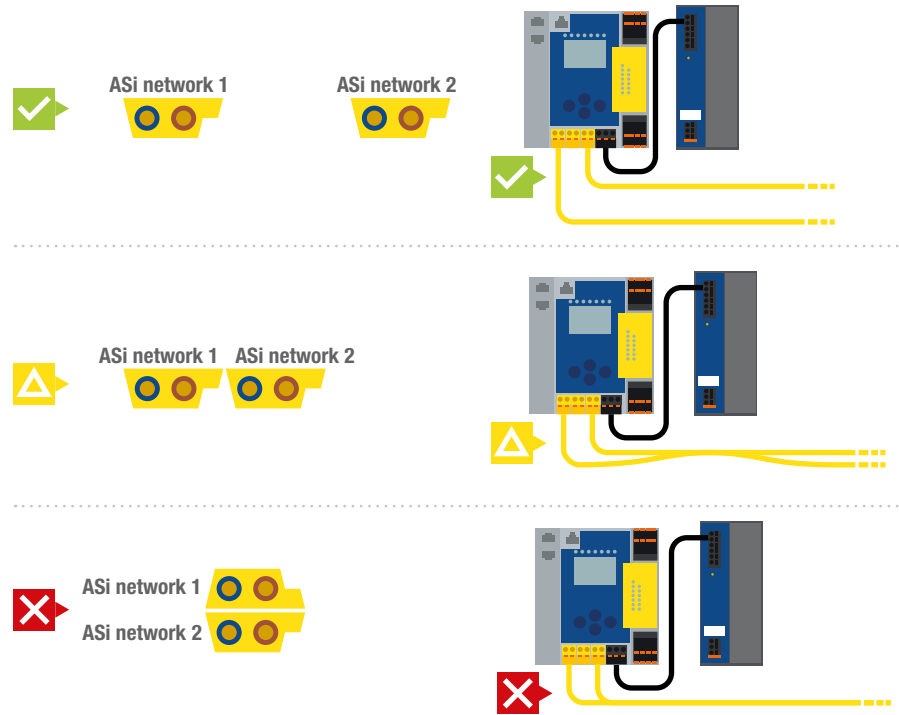

**i** This is a short version of our installation guide. One Detailed version can be found here:

**Go to the installation guide →**

If you have any questions, please contact us: **+49 621 33996-940**